

PMC-1401THX

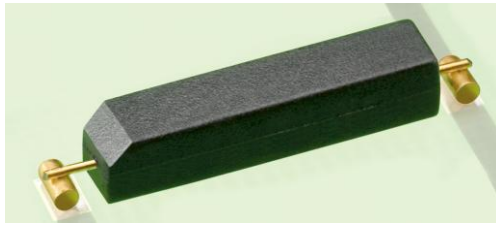

PMC-1401THX

Latching SMD Reed Switch

Electrical Characteristics @ 25 °C

Contact form		E
Contact material		Ru
Contact rating max.	W / VA	5
Switching voltage max.	VDC	140
	VAC	100
Switching current max.	A	0.5
Carry current max.	A	1
Breakdown voltage min.	VDC	180
Contact resistance max. (initial)	mΩ	200
Insulation resistance min.	Ω	10 ¹⁰

Magnetical Characteristics (of unmodified Reed Switch) @ 25 °C

Pull in range available	AT	n.d. - n.d.
Drop out min.	AT	n.d.
Test coil	TC	n.d.
Test equipment tolerance	±AT	

Operating Characteristics @ 25 °C

Switching frequency max.	Hz	500
Resonant frequency typ.	Hz	5000
Operate time max. (incl. bounce)	ms	0.4
Release time max.	ms	0.1

Environmental Characteristics

Operating temperature	°C	-20 to +125
Storage temperature	°C	-20 to +125
Soldering temperature max.	°C	255
Vibration (50-2000 Hz)	g	20
Shock (1/2 sin 11 ms)	g	20
Lead tensile strength min.	kg	3

Features

- Small size
- Polarity sensitive
- Zero power consumption
- Suitable for lead-free soldering
- Suitable for automated assembly
- Tape & reel packaging
- Over 1 billion reliable operations at dry circuits or low level loads

Approvals



Dimensions in mm

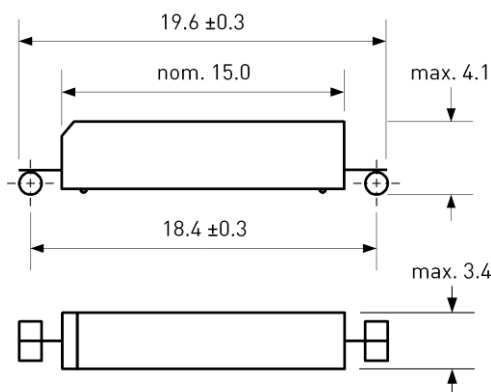

North Pole marked = chamfered edge

Ordering Information

Packing Unit	2000 pcs
Weight per piece	0.4 g
Weight per package	1200 g
Reel size	13 inches
Standard AT ranges	

Ordering example

PMC-1401THX

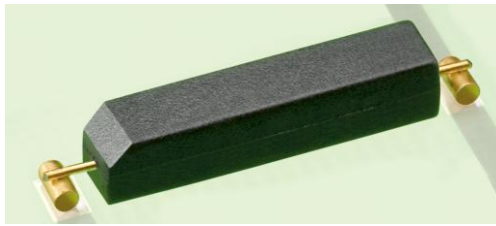

PMC-1401THX

Latching SMD Reed Switch

Recommended PCB Layout in mm

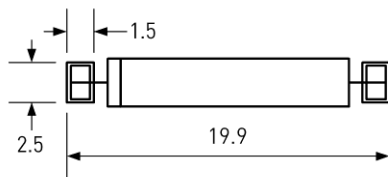

Pad sizes

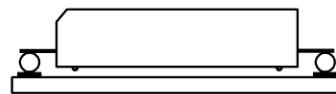

Final assembly position

Soldering Information

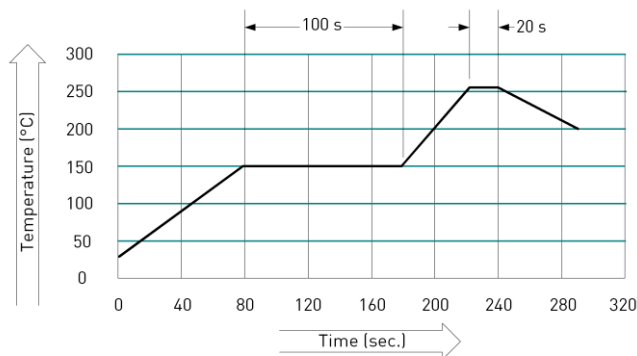

Mounting Force

Recommended Mounting Force	3 N
Maximum Mounting Force	8 N

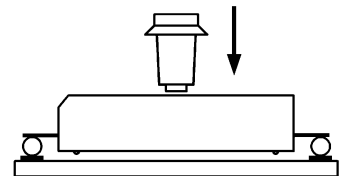

Tape Dimensions in mm

Tolerance ± 0.1 unless otherwise specified

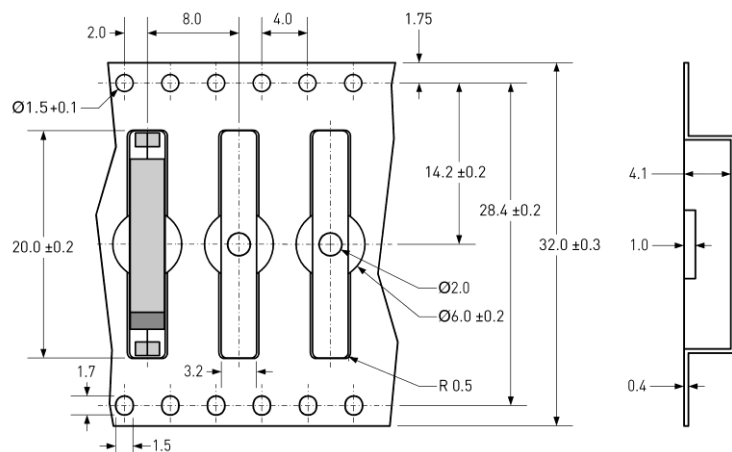

Remarks

When placed onto ferromagnetic parts switching distance of PMC-1401THX may reduce.

Electromagnetical influences and magnetic fields may change the switching behaviour of the SMD Reed Switch.

Please pay attention to MSL instructions as per label on reel.